

# Repairs reporting guide for tenants



# About this guide

This guide will help you describe clearly any repair problems in your home that we, your landlord, are responsible for carrying out. By giving as much information as you can, you can help them decide who is the best person to carry out the repair, what equipment and parts they need to bring, and how quickly they need to get to you.

## Before you contact us

- Look on the page opposite under the heading **Describing your repair** and decide which section relates to your repair problem.
- Go to that section and see what we need to know. You will see pictures of the main items you may need to talk about and questions you may need to answer. These will help you name the parts or describe the repair problem correctly.
- Make a note of the details and then have the book with you when you talk to us.

## Who to contact about your repair

During office hours.....

.....

Outside office hours (emergencies only).....

.....

.....

.....

# Contents

**Emergencies - what to do** ..... 1

**Who is responsible for repairs** ..... 3

## **Describing your repair**

- Baths, basins and showers ..... 5
- Doors and frames ..... 7
- Door locks and fittings ..... 9
- Drains and wastes ..... 11
- Electrics ..... 13
- Floors and stairs ..... 15
- Garden area ..... 17
- Garages and stores ..... 19
- Gutters ..... 21
- Heating ..... 23
- Kitchen fittings ..... 25
- Roofs and chimneys ..... 27
- Toilets ..... 29
- Walls and ceilings ..... 31
- Water, pipes and taps ..... 33
- Windows ..... 35

## **Handy hints**

- Dealing with blockages: How to unblock a bath, basin, shower, sink or toilet ..... 37
- Resetting a trip switch: How to put the electricity back on when it has 'tripped' off... 39
- Condensation: How to prevent and control it..... 41
- Smoke detectors: How to test them and what to do when the alarm goes off ..... 43

# Emergencies - what to do

## Gas (smell, leak or fumes)

- **Call the Gas Emergency Service immediately on 0800 111999. Use a phone outside your home** (even using a mobile inside could spark an explosion).
- Turn off the gas and open windows. Turn the handle at the meter to the flat (horizontal) position.
- Don't smoke or switch anything electrical on or off until the problem is fixed.

## Smoke, fumes or your smoke detector alarm sounds

- If you can smell or see smoke, call **999** or **112** immediately.
- If there is no sign of smoke or fire, check whether the alarm has been set off by something else.

## Electricity (fittings or appliances sparking, flickering, giving off shocks or no electricity at all)

- Turn the mains switch on the consumer unit (fuse box) to OFF.
- If you have a power cut, call the emergency number given in your phone book.  
Write it down here .....

## Water (burst pipe, flooding or no water at all)

- To stop flooding, turn the mains stoptap to the right (clockwise ↻) or press the surestop switch (if there is one).
- If you need to shut off the supply of water to a fitting, such as a toilet or basin, you can use the isolation valve on the pipe leading to it (if there is one fitted).
- If you have no water supply at all coming into the property, phone your local water company. You will find the number in the phone book or on your latest water bill.  
Write it down here .....

## Where is it in your home?

It is a good idea to fill in the boxes below to show where these items are in your home. This information could be very important if there is a problem in your home, particularly if it is an emergency.

- **Gas meter**

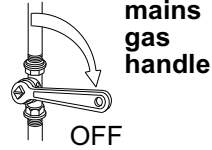

- **Consumer unit (fuse box)**

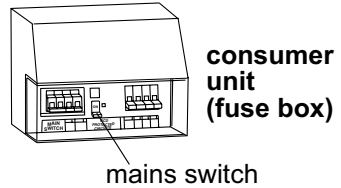

- **Mains water stoptap or surestop switch**

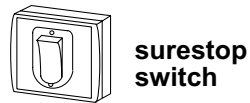

- **Isolation valves**

1

2

3

4

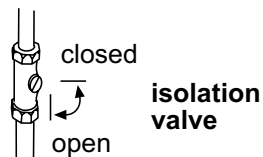

# Who is responsible for repairs

## What repairs we must do

As your landlord, we must, by law, keep the main structure and the outside of your home in good repair so that it is safe and protected from wind, rain and so on.

We must also carry out certain essential repairs that might affect the health and security of you and your family.

These relate mainly to heating breakdown, faulty electrical equipment, blocked main drains, burst pipes, and doors that cannot be shut and locked.

Under the terms of the tenancy agreement, we will also carry out most repairs to the main fittings we have provided inside your home and will also do repairs in shared areas, such as the common stairways, passageways, rubbish chutes, and repairs to shared equipment, such as lifts and door entry systems.

## Accidents, damage or neglect

If repairs are needed because you have not looked after the home properly or someone in your home has caused damage, you are expected to get it repaired. This includes damage done by any visitors, children or pets. You will have to do the work yourself or arrange and pay for someone else to do it.

Sometimes, particularly where the situation is dangerous, we may carry out the repair for you but you will usually have to pay for it.

If damage is caused by criminal behaviour (for example vandalism or a break-in) you should report it to the police and also to us.

## Home contents insurance

We will insure the building you live in but not what you have in it. For example, if a water pipe bursts they will only pay for carrying out the repair, not for any damage to your belongings.

If you take out home contents insurance, you should be able to claim back the costs of accidental damage to your personal belongings, carpets, furniture and decorations, including damage from a fire or flood. It will usually also cover the cost of certain items if they are stolen from your home.

When choosing an insurance scheme, make sure that it will cover broken glass and broken locks on doors and windows.

## What repairs you must do

You are expected to carry out some repairs. These may be listed in your Tenancy Agreement, your Tenants Handbook or in a separate leaflet. Some of the most common repairs you must do are:

- getting new keys or changing locks if you lose or break your keys or you get locked out
- getting new glass put in your window or door if it was broken by accident
- replacing plugs and chains on basins, sinks and baths and seats on toilets
- replacing light bulbs and fluorescent tubes in your home
- resetting trip switches when the electrical supply in the home cuts out. See **Resetting a trip switch** on page 39
- tightening up loose handles, catches, hinges and so on
- trying to clear blocked basins, sinks, baths and toilets. See **Dealing with blockages** on page 37 for guidance. If you have tried and failed, you should ring us.

You are also expected to look after the home. In particular it is important not to allow condensation to build up (see **Condensation** on page 41) or to allow problems to get worse because you have not contacted us about them.

# Baths, basins and showers

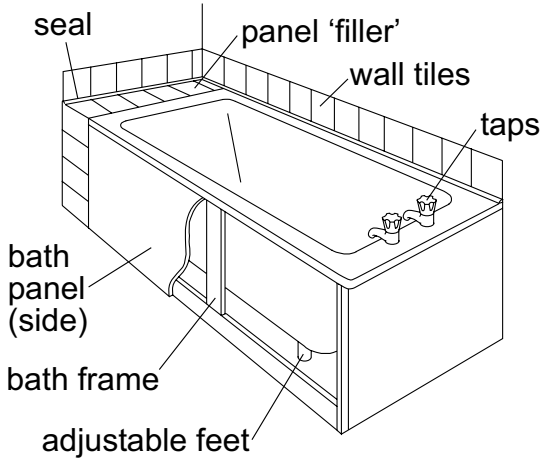

**bath**

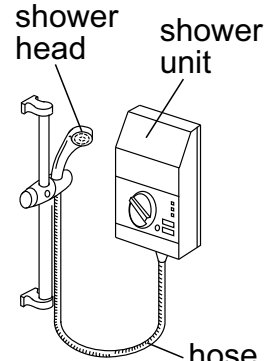

**electric shower**

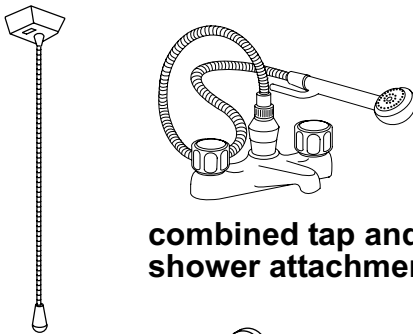

**combined tap and shower attachment**

**shower ceiling switch**

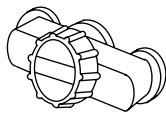

**shower mixer valve**

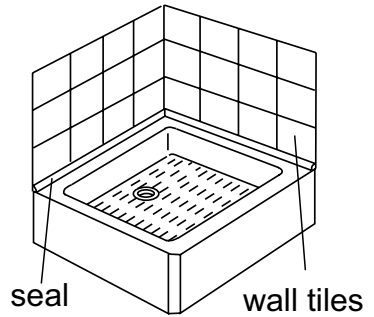

**shower tray**

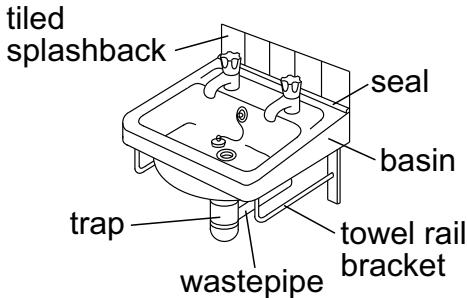

**wash hand basins**

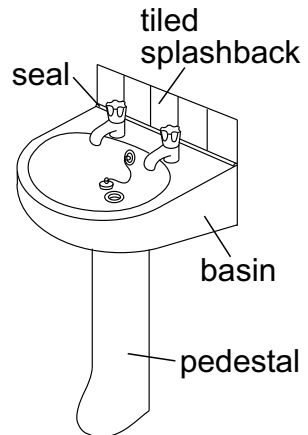



## What we need to know:

### Baths

- What is the problem: bath cracked, chipped, unstable or stained; seal leaking; waste leaking or blocked?
- What is it made of: metal or plastic?
- What colour is it?
- If it is leaking, where is the leak showing?
- If it is blocked, is the basin blocked too?

### Bath panels

- What is the problem: panel loose, broken or rotten; corner angle come off?
- What is it made of: plastic, metal or hardboard?
- Is the problem with the side panel or the end panel?

### Basins

- What is the problem: basin cracked, loose or stained; seal leaking, waste leaking or blocked?
- What is it made of: plastic or ceramic?
- What colour is it?
- Is it fixed on wall brackets, on a pedestal, or inset in a unit?
- Can it still be used? Is it safe?
- If it is leaking, where is the leak showing?
- If it is blocked, is the bath blocked too?

### Showers

- What is the problem: shower not working, leaking, or a part broken; curtain rail loose or broken; pull cord not working?
- Is it an electric-powered shower? If not, is it a shower unit with a mixer tap or is it a combined tap and shower attachment on the bath?
- What type of tray does it have: ceramic or plastic?

For **taps**, **pipes** and **water** see page 33.

For **wastes** and **blockages** see page 11.

For **wall tiles** see page 31.

# Doors and frames

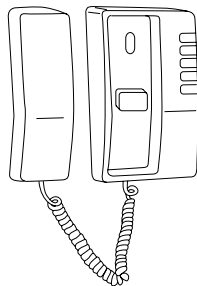
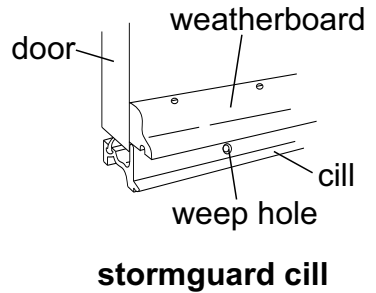
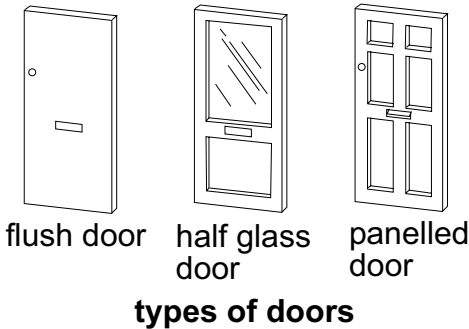
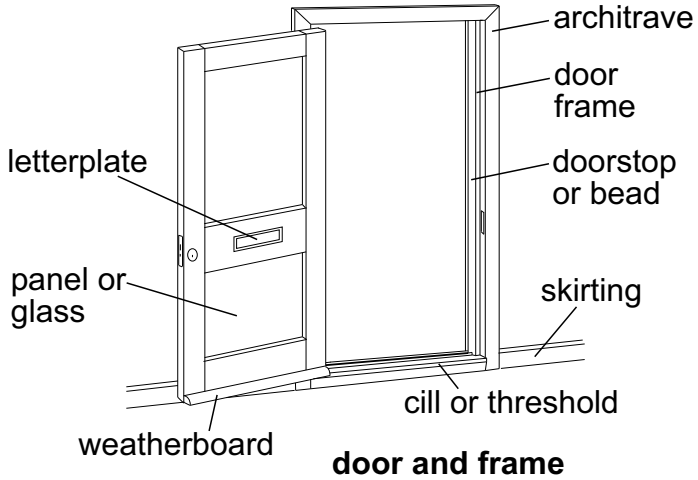

**door entry handset in the home**

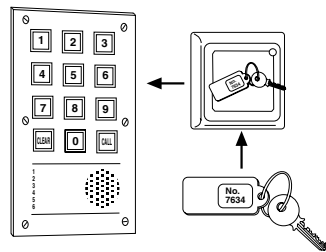

**door entry system unit at main entrance**

## What we need to know

### Doors and frames – outside doors

- What is the problem: door sticking, not closing properly, damaged, draughty or rain coming in underneath; frame loose; hinge coming loose?
- Which door is it: front, back, side, patio, or a garage or shed door?
- Is it a shared or common entrance door?
- What is it made of: wood, plastic (upvc) or metal?
- What style of door is it (see pictures opposite)? Does it have panels? Does it have a glass pane in it?
- If it is damaged, which part needs repairing or replacing?
- Can you lock the door? Is your home secure?

### Doors and frames – inside the home

- What is the problem: door sticking, damaged or not closing properly; frame loose; hinge coming loose?
- If it is damaged, which part needs repairing or replacing?
- Is it a fire door with an automatic closer on it?
- What style of door is it (see pictures opposite)? Does it have panels? Does it have a glass pane in it?
- If it is sticking, have you had a new carpet or other type of flooring fitted recently?

### Door entry system

- What is the problem: door not unlocking, telecom not working (you or your visitor cannot hear anything that is said), buttons not working?
- Is the problem with the handset in your home or with the unit at the main entrance?

For **locks**, **latches** and **other door fittings** see page 9.

# Door locks and fittings

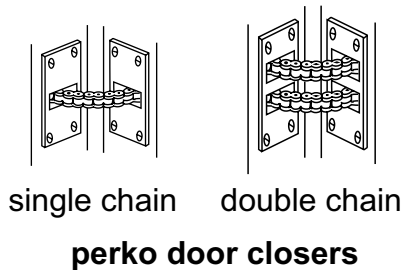
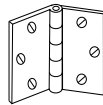
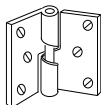
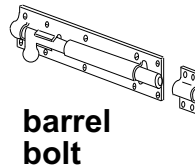
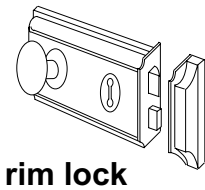
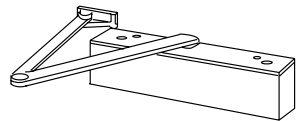
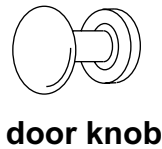
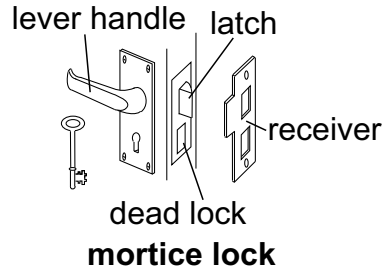
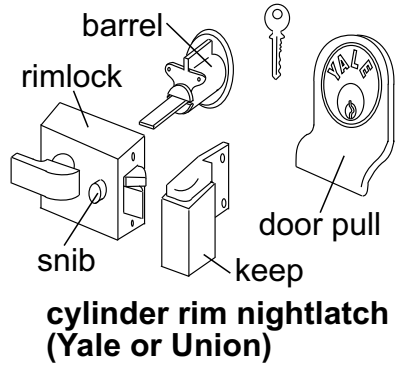
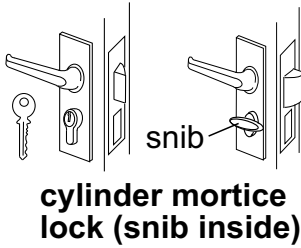

**door hinges**

## What we need to know

### Locks

- What is the problem: key lost or left inside; lock stiff, broken or not working; latch not fitting properly into the keep?
- What type of lock is it (see pictures opposite)?
- Which door is it on?

### Bells

- Did you or a previous tenant fit this or was it provided by us?
- Is it powered by a battery or is it wired into the mains electricity?

### Handles or knobs

- What is the problem: can't open the door; handle stiff, loose, broken or come off?
- What type of handle or knob is it (see pictures opposite)?
- Which door is it on?

### Door closers

- What is the problem: part come loose or broken; door not closing, slamming or closing too fast (spring not working or broken)?
- What type is it: overhead or perko?
- What door is it on?

### Spy holes, chains and other fittings

- Did you or a previous tenant fit this or was it provided by us?

# Drains and wastes

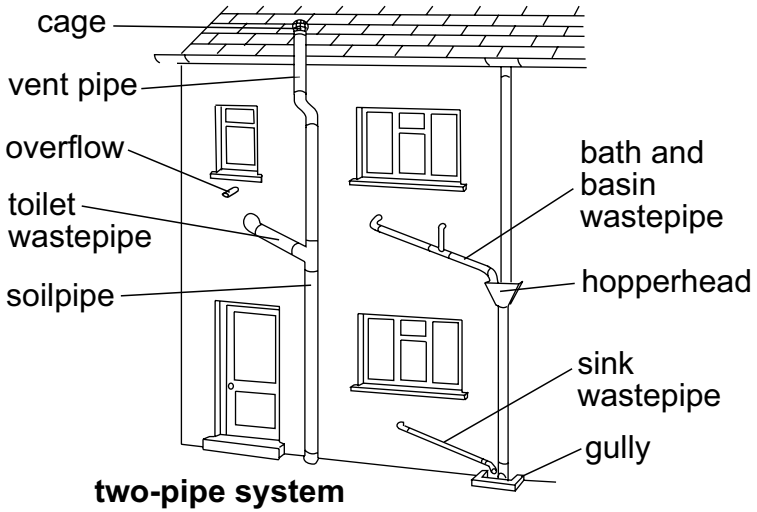

unscrew here to clean

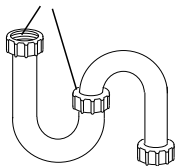

**'S' trap**

unscrew here to clean

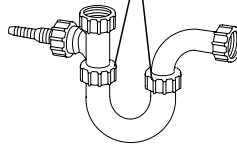

**combination trap  
(for washing machine)**

unscrew here to clean

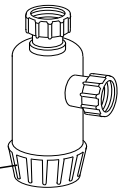

**bottle trap**

cover frame

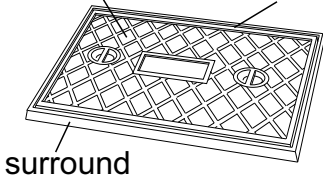

**inspection chamber**

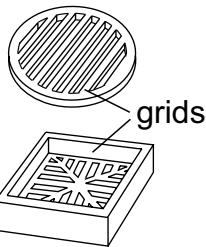

**gully grids**

downpipe hit and miss cover

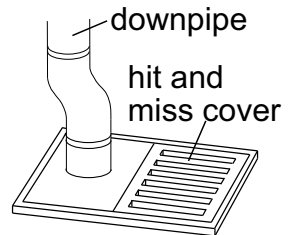

**back inlet gully**

## What we need to know

### Wastepipes

- What is the problem: wastepipe leaking or smelling; water not flowing away; seal broken or loose?
- Which fitting is the waste coming from: bath, basin, sink, shower or toilet?
- If it is blocked, are any other fittings blocked too (bath, basin, sink, shower or toilet)? This is often called 'backing up'.
- If it is leaking, where is the leak showing?

**Advice:** If a wastepipe is leaking, do not use it until it is fixed, or put a bowl or bucket under it to catch the water that leaks.

### Soilpipes

- What is the problem: soilpipe leaking, damaged or blocked; waste backing up into the toilet?
- What is it made of: plastic or cast iron?
- Where is it? How easy is it to get access to it?

### Main drains

- What is the problem: drain smelling or overflowing; inspection chamber (manhole) cover loose, damaged or missing?
- Where is the inspection chamber (manhole): in the garden, on a path, on the pavement or in the road?

### Gullies

- What is the problem: gully blocked, grid loose or missing, surround damaged or missing?
- Where is the gully: beside the house, on a path or driveway, or in the road?
- What shape is the grid: round or square?
- What is the grid made of: metal or plastic?
- Is the surround in which it sits made of metal or concrete?

# Electrics

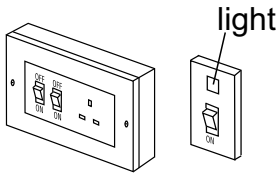

**cooker control units**

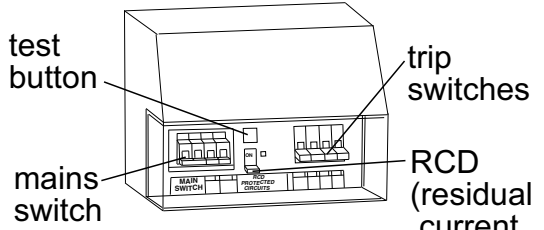

**consumer unit (fuse box)**

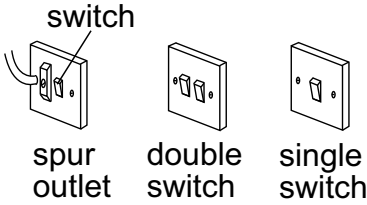

**switches**

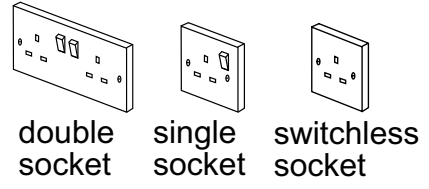

**sockets**



**smoke detector**



**carbon monoxide detector**



**extractor fan**



**bulkhead light**

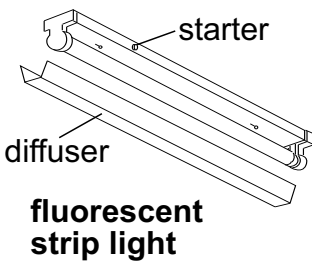

**fluorescent strip light**



**batten lampholders**

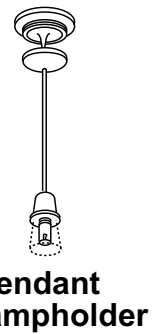

**pendant lampholder**

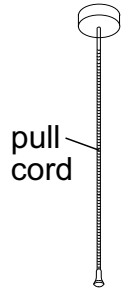

**ceiling switch**



**sealed bathroom light**



## What we need to know

### Lights outside the building or in an internal shared area

- What is the problem: light not working, flickering, loose, or a part missing or damaged?
- Where is the light?
- What type of light fitting is it: bulkhead, fluorescent strip light (see pictures opposite) or some other type?
- Does the light fitting have a number on it?

### Lights and power inside the home

- What is the problem: no lights or power working anywhere in the home; no lights and/or power working in part of the home; a light fitting, switch or socket not working, loose, broken, sparking or giving you a shock when you touch it?
- If there are no lights working at all, are nearby homes or buildings also without lights? Are the power sockets also not working?
- If the lights or power are not working in part of the home, have you checked whether something has caused it to trip off? You should try to reset the trip switches. See **Resetting a trip switch** on page 39.
- If it is a problem with a switch, what type of switch is it (see pictures opposite)?
- If it is a problem with a light fitting, what type is it (see pictures opposite)? Have you tried a new light bulb?
- If it is a fluorescent light, is it shimmering, flickering or only lighting at the ends? Have you tried putting in a new starter and/or a new fluorescent tube?
- If it is a problem with a socket, what type is it (see pictures opposite)?
- Is there water leaking onto any switches, sockets or fittings?
- Are there any sparks coming from any switches, sockets, or fittings, or are there any bare wires showing?

# Floors and stairs

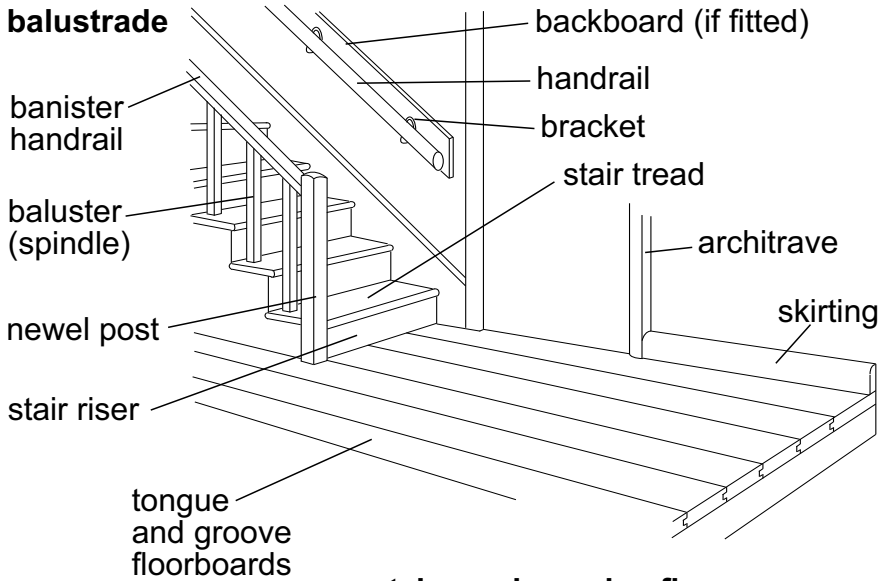

**stairs and wooden floor**

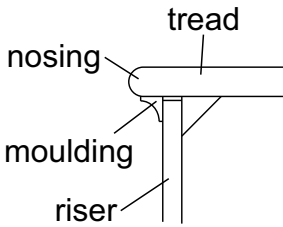

**step details**

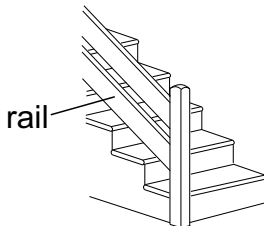
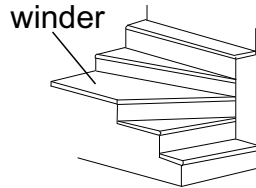

**ranch style**

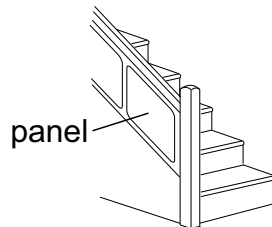

**panel style**

## What we need to know

### Floors

- What is the problem: floorboard loose, squeaking or broken; floor tiles cracked or loose; floor covering lifting or damaged; skirting loose, missing or damaged; damp on the floor?
- What is the floor made of: floorboards, chipboard or concrete?
- What type of floor covering is it, for example: quarry or clay tiles (usually red), plastic tiles or sheeting, or non-slip flooring?
- How many boards, panels or tiles are affected, or what area is affected (roughly)?
- If it is a problem with tiles, what colour are they?
- If some skirting needs replacing, how high is it?
- If there is dampness showing, do you know where it could be coming from?

### Stairs

- What is the problem: tread or riser loose, squeaking or broken; stair nosing loose or damaged; handrail loose or broken; part of the balustrade missing?
- What style of staircase is it (see pictures opposite)?
- What part needs repairing or replacing?
- If the problem is with the stair nosing, is it made of wood, metal, plastic or rubber?

# Garden area

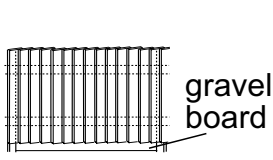

feather-edged boarded

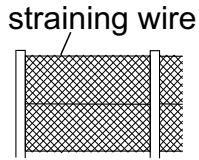

chain link

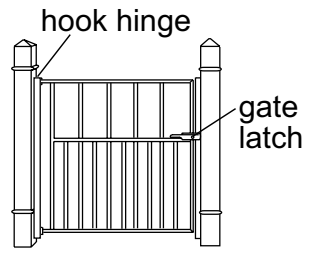

metal gate

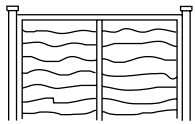

larch lap panel

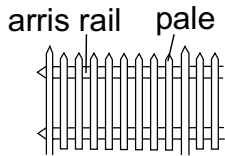

palisade

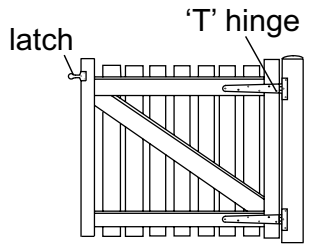

wooden gate

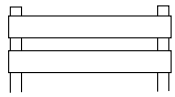

post and rails (ranch)

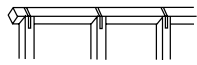

paddock rail

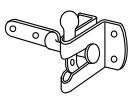

automatic latch

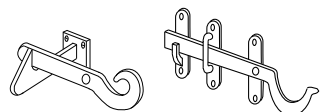

hand latches

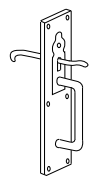

suffolk latch

## gate latches

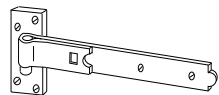

hook and band hinge

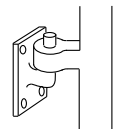

hook hinge

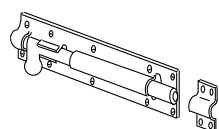

barrel bolt

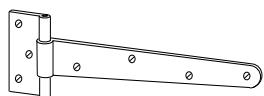

'T' hinge

## hinges

## What we need to know

### Fences, posts and gates

- What is the problem: fence or post broken or unstable; gate missing, damaged or come off its hinges; gate latch broken?
- Where is the fence, for example: next to the building, down the side of the garden between you and a neighbour, or bordering a road or public path?
- What type of fencing is it (see pictures opposite)?
- How high is the fence or post: head-high, waist-high or knee-high?
- How much is affected (roughly)?
- If a post, what is it made of: wood, metal or concrete?
- If a gate, what is it made of: metal or wood? Is it a single gate or a double gate?
- If a gate latch, what type is it (see pictures opposite)?
- Is there any danger to people?

### Paths, paved areas and steps

- What is the problem: path uneven, slab broken or cracked, steps crumbling or missing?
- What is the path made of: concrete, tarmac, slabs (pre-cast concrete or stone) or brick blocks?
- If slabs, what shape are they: square or oblong?
- What area is affected (roughly)?
- What are the steps made of: concrete, tarmac, slabs (pre-cast concrete or stone) or bricks?
- Is there any danger to people?

# Garages and stores

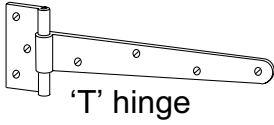

'T' hinge



rising butt hinge



butt hinge  
hinges

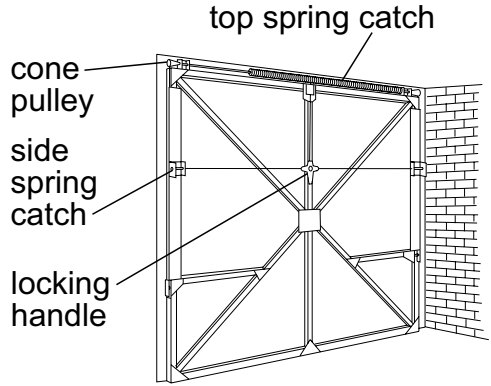

spring-balanced  
up-and-over garage door

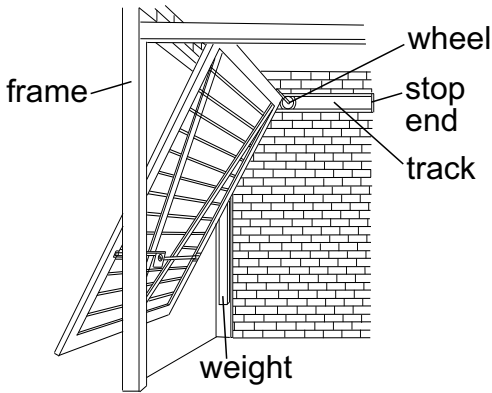

up-and-over garage door

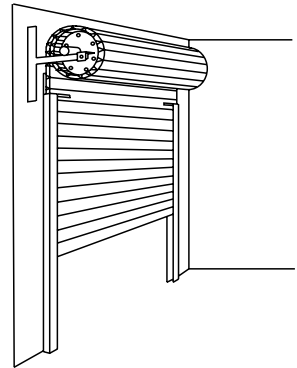

roller garage door



cylinder  
lock



henderson  
lock

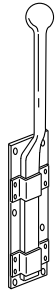

monkey-tail  
bolt

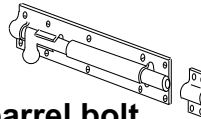

barrel bolt

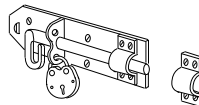

pad bolt

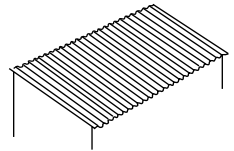

corrugated  
roof

## What we need to know

### Garages

- What is the problem: door jammed or damaged, frame damaged, roof damaged, lock broken, key lost?
- Can you still open and close the door? If not, is your car stuck inside?
- What type of garage door is it: overhead track, spring balanced, or roller?
- What type of lock does it have (see pictures opposite)?
- What kind of roof covering does it have: corrugated or flat? If corrugated, is it plastic or metal?

### Sheds, bin stores and other outbuildings

- What is the problem: door jammed or damaged, frame damaged, roof damaged, lock broken, key lost?
- Did you or a previous tenant put it up, or was it provided by us?
- What kind of roof covering does it have: corrugated, flat or tiles? If corrugated, is it plastic or metal?

# Gutters

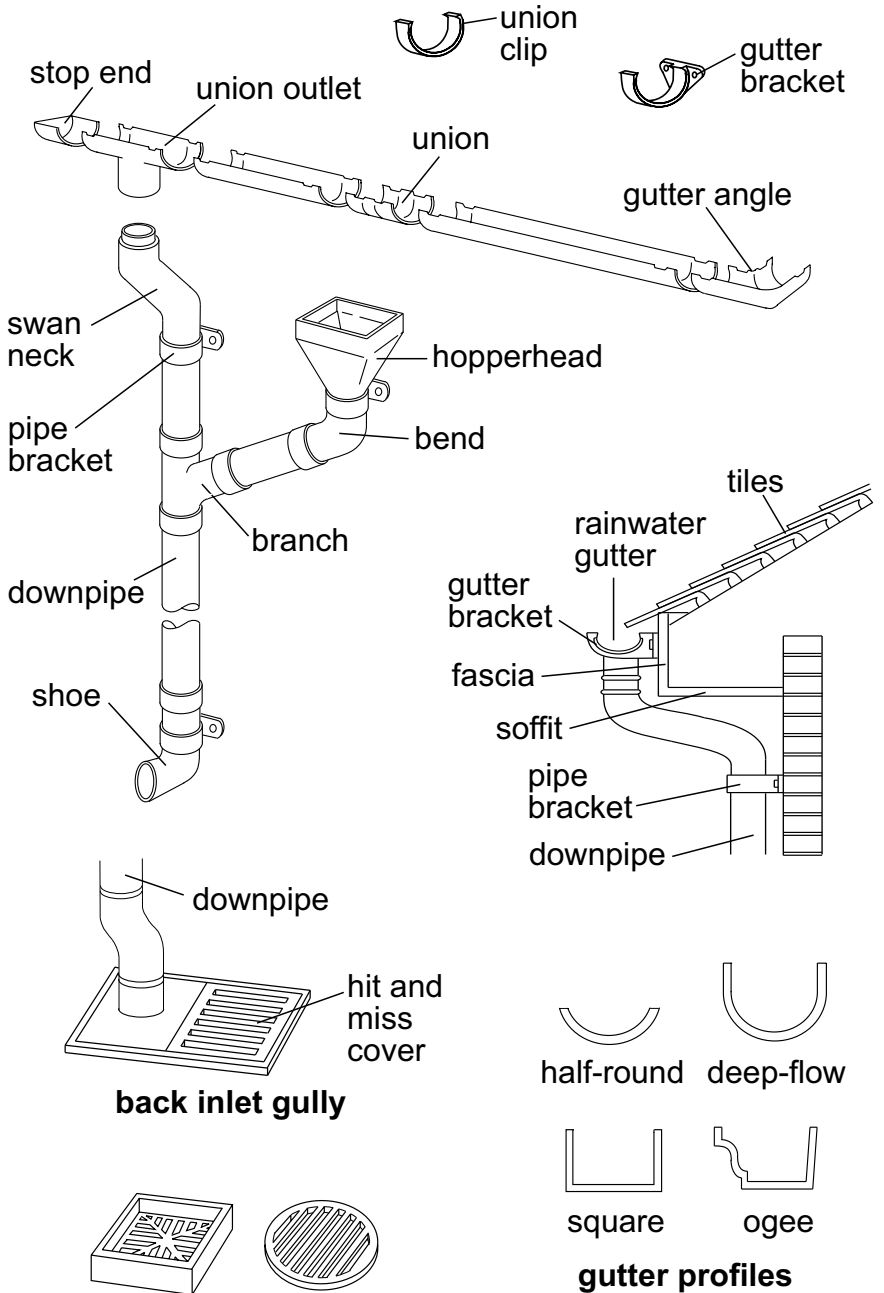



## What we need to know

### Gutters

- What is the problem: gutter loose, leaking, overflowing (blocked), fallen down, or a part is broken or missing?
- If it is overflowing, where is the water falling from: the gutter or a hopperhead?
- If a part is broken or missing, which part is it (see pictures opposite)?
- If it is a length of guttering, how much is missing (roughly)?
- What is it made of: metal, plastic (upvc) or some other material?
- What shape is it: half-round, deep-flow, square or ogee?
- On which side of the building is it: front, back or side?
- How many storeys high is the building?

### Rainwater downpipes

- What is the problem: pipe loose, leaking, fallen down or a part is broken or missing?
- If a part is broken or missing, which part is it (see pictures opposite)?
- If it is a length of pipe, how much is missing (roughly)?
- What is it made of: metal, plastic (upvc) or some other material?
- On which side of the building is it: front, back or side?
- How many storeys high is the building?

### Gullies

- What is the problem: gully blocked, grid loose or missing, surround damaged or missing?
- Where is the gully: beside the house, on a path or driveway, or in the road?
- What shape is the grid: round or square?
- What is the grid made of: metal or plastic?
- Is the surround in which it sits made of metal or concrete?

# Heating

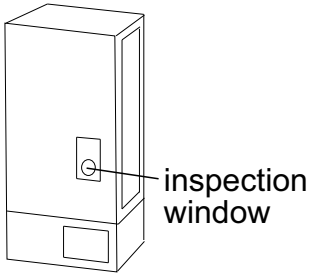

**wall-mounted  
central heating  
boiler**

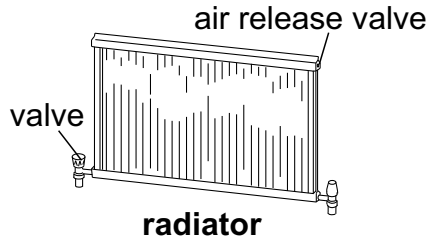

**radiator**

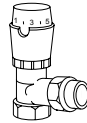

**thermostatic valve**

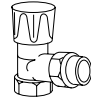

**wheelhead valve**

**radiator valves**

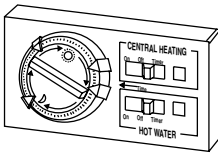

**timeclock  
programmer**

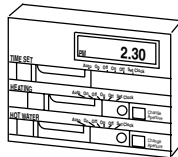

**digital  
programmer**

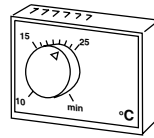

**room  
thermostat**

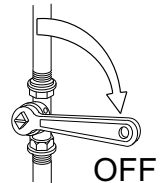

**mains  
gas  
handle**

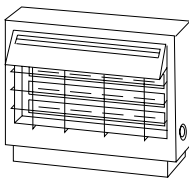

**gas fire**

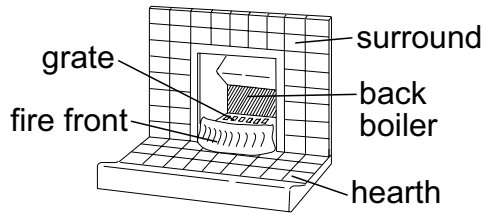

**open fire**

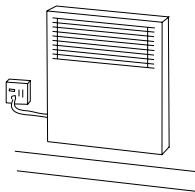

**panel heater**

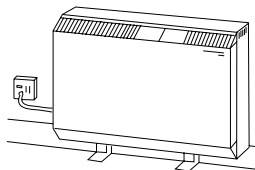

**storage heater**

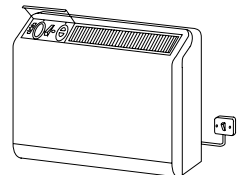

**convector heater**

## What we need to know

### For all heating problems

- What is the problem: heating not working or not switching on or off at set times, a radiator is leaking or not getting warm?
- What kind of fuel does your system use: gas, electricity, oil, solar energy (from panels) or solid fuel (coal or wood)?
- Is it a shared heating system where a common boiler is used to heat several homes?
- If the heating is not working, have you checked:
  - if the room thermostat has been adjusted? A good temperature is between 18 and 21 degrees
  - if the boiler or heating appliance has been switched off?
  - if the gas or electricity supply has been turned off or been cut off for any reason?
  - if the programme is switching on and off correctly? Check the times you have set.

### Gas central heating

- Do you have a boiler? Is it mounted on the wall or standing on the floor? Do you know if it is a combination boiler which heats the water instantly when you turn on the hot taps?
- Do you have radiators, or is it a warm-air system where the heat comes out of vents near the floor?

### Electric central heating

- What kind of heaters do you have: storage heaters, panel heaters, convector heaters, radiators with water in them, or is it a warm-air system with vents near the floor?

### Solid fuel heating

- Does it have an open fire or closed-in fire?
- Does it have a back boiler?

### Stand alone heaters or fires

- What type is it: gas fire, electric bar fire, bathroom heater, open wood or coal fire?

For **hot water** see page 33.

# Kitchen fittings



**ball catch**

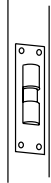

**roller catch**



**door knob**



**'D' handle**

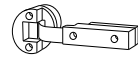
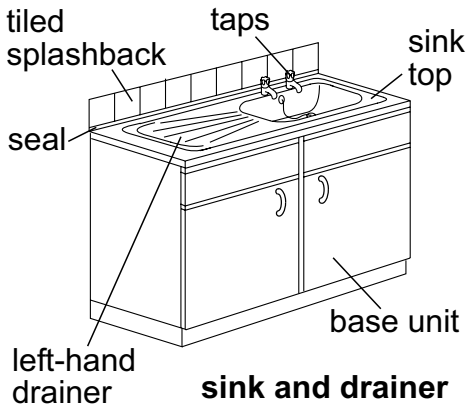

**concealed hinge**

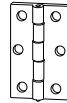

**butt hinge**



**flush hinge**

**hinges**

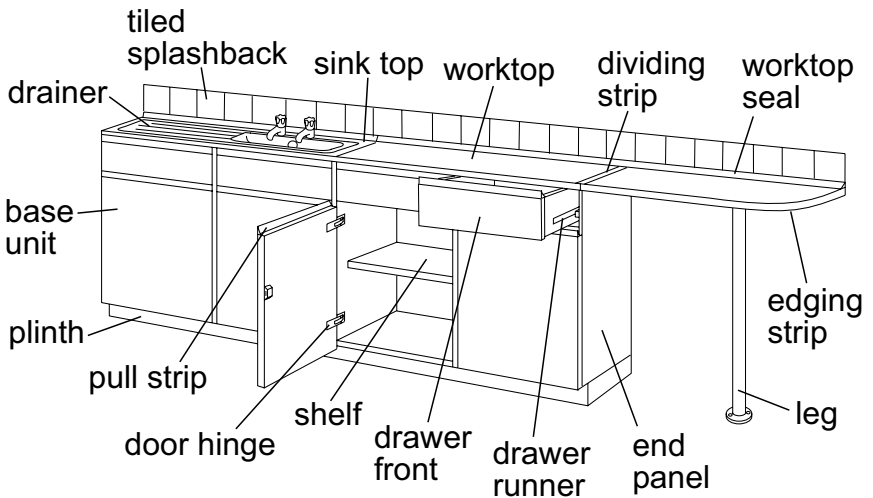

## What we need to know

### Wall and floor units

- What is the problem: wall or floor unit loose or damaged, worktop loose or broken, cupboard door or drawer damaged, cupboard hinge or catch broken?
- What type of unit is it: wall or floor? Is it a tall unit or a corner unit? Is it a single or a double unit?
- What kind of handle or catch does it have (see pictures opposite)?
- What kind of hinge does it have (see pictures opposite)?

### Sink and worktops

- What is the problem: worktop loose or broken, sink unit damaged, seal around sink leaking, sink stained?
- If it is a problem with the sink unit, what type is it: is the sink and drainer inset in the worktop or does the metal go right over the edges?
- If a worktop is damaged, how much is affected (roughly)? What colour and style is it?

### Wall tiles

- What is the problem: tiles fallen off, broken or chipped; seal or grouting damaged or missing?
- What shape are the tiles: square or oblong?
- What colour are they? Are they patterned?
- How many are affected?

For **pipes**, **taps** and **water** see page 33.

For **wastes** and **drains** see page 11.

# Roofs and chimneys

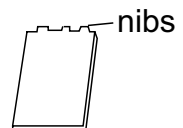
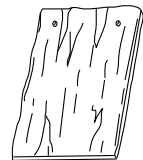
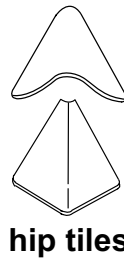
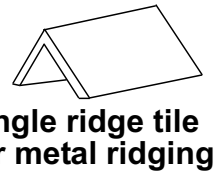
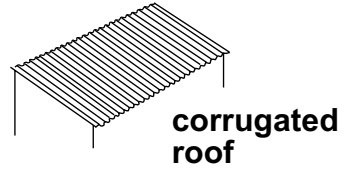
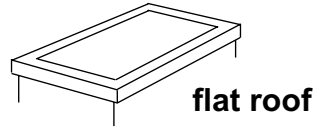
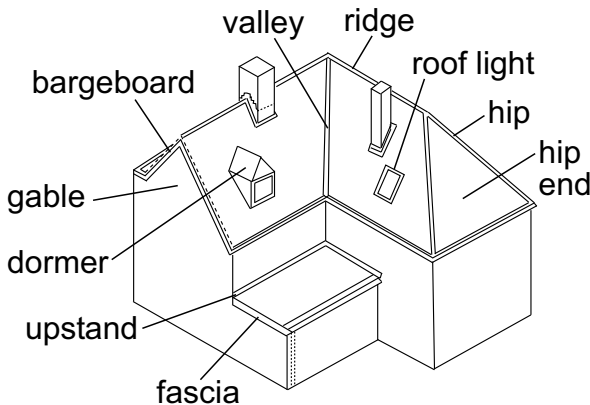
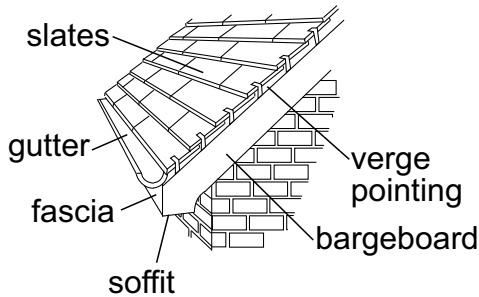
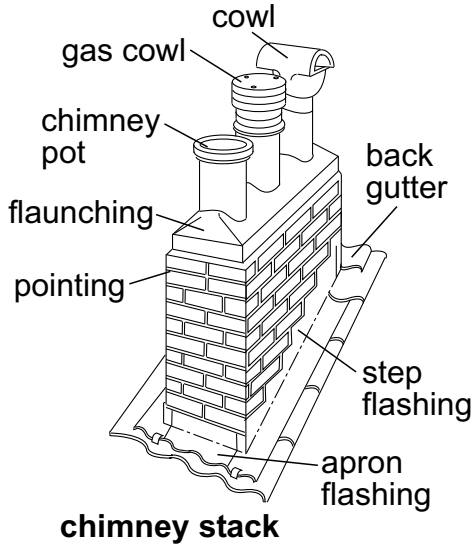

## What we need to know

### For all roof problems

- What side of the building is the problem: the front, back or side?
- How many storeys high is the building?
- Do you think the situation is dangerous?

### Roofs and chimneys

- What is the problem: roof leaking; tiles or slates loose or broken; chimney pot or cowl fallen or loose; chimney stack crumbling?
- If the roof is leaking, where is the water coming through? Can you contain the leak?
- What type of roof is it: flat or sloping?
- What type of roof covering is it: slates, tiles, corrugated sheeting, or a flat roof with felting or asphalt?
- If it is a problem with corrugated sheeting, what is it made of: plastic, metal or some other material?
- If it is a problem with roof tiles, what type are they: flat, ridge, interlocking or hip? How many are loose or broken?
- If it is a problem with the chimney, is it shared with a neighbouring property?

### Roof boarding or wall cladding

- What is the problem: boarding loose, fallen off, broken or rotten?
- Which type of board is it: fascia, soffit or bargeboard?
- What is it made of: plastic or wood?

# Toilets

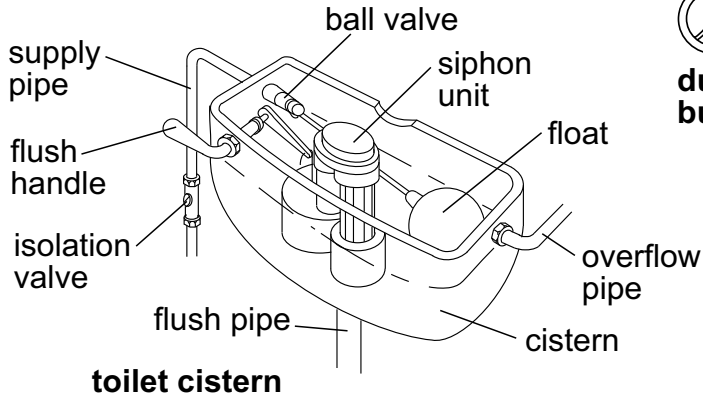

**dual-flush button**

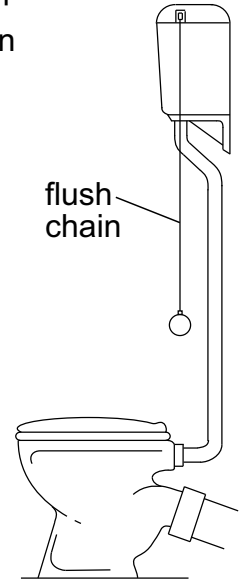
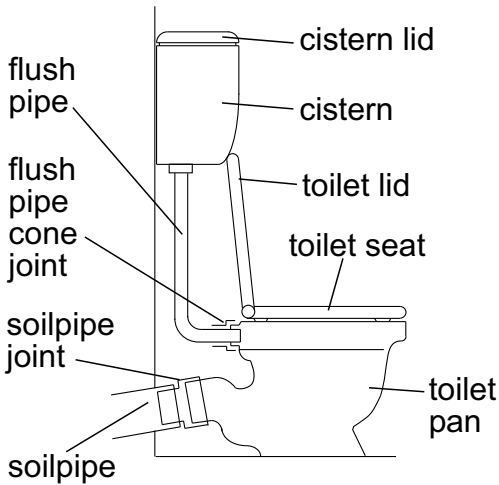

**high-level cistern**



**close-coupled**

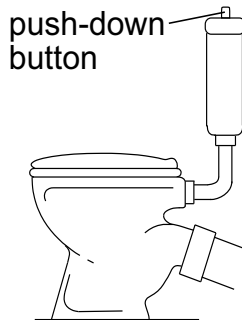

**flush-panel**  
**low-level cisterns**



**standard**



## What we need to know

### Leaks and blockages

- What is the problem: toilet blocked, cistern leaking, pan leaking, overflow running?
- If the toilet is blocked, do you have another toilet you can use? If you are in a block of flats or group of homes, do your neighbours also have blocked toilets? This will be a main drain problem.
- If the toilet or cistern is leaking, where is the leak coming from: a water supply pipe or the flush pipe (clean water) or from the soilpipe (waste water)?

**Advice:** If it is leaking from the soilpipe, make sure you do not use the toilet. If it is leaking from a supply pipe or the flush pipe, put a container under it until it is fixed or turn off the supply of water at the isolation valve. See page 2.

### Cistern and pan

- What is the problem: cistern not flushing, flush handle or chain broken, seat loose or broken, pan cracked?
- What type of cistern is it: high-level with chain or low-level? If low-level, what type is it: standard, flush-panel or close-coupled?
- If the pan or cistern is cracked or broken: what colour is it?
- How do you flush the toilet: with a handle, chain or push-down button? If it is a button, is a dual-flush button?

# Walls and ceilings

a possible cause of dampness is earth mounded over the damp-proof course

rising damp is usually shown by a 'water' mark to a height of 2-3 feet

black mould usually shows condensation problems

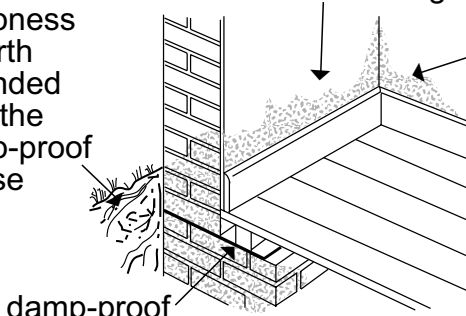

damp-proof course

**damp and mould**

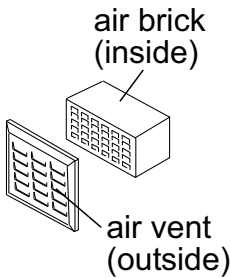

**ventilation**

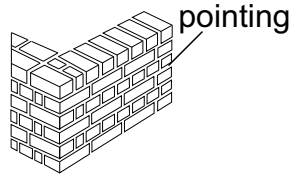

full brick wall

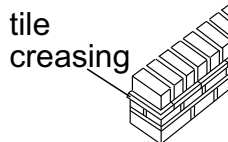

brick on edge coping

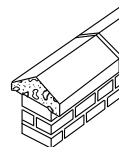

pre-cast concrete coping

**boundary walls**

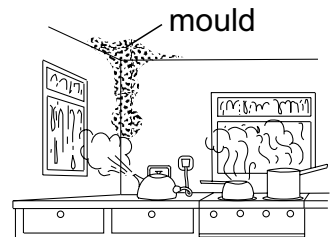
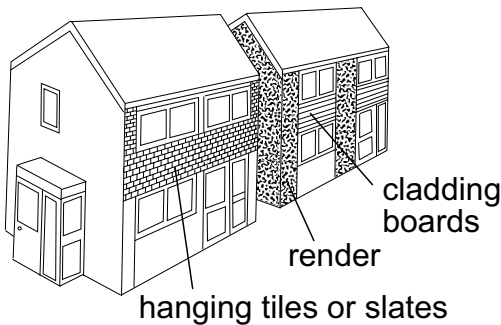

**condensation**

## What we need to know

### Outside walls

- What is the problem: bricks fallen off or crumbling; pointing loose; coping loose, missing or broken; render fallen off; hanging tiles or slates fallen off; boarding loose, broken, rotten or fallen off?
- What is the wall made of: bricks or concrete blocks?
- What kind of wall surface does it have: render (pebbledash or smooth), cladding boards, or hanging tiles or slates?
- If there is a problem with cladding boards, what are they made of: plastic or wood? How many boards are affected?

### Inside walls and ceilings

- What is the problem: wall plaster loose or crumbling, ceiling plaster bulging, condensation or mould on walls or ceiling, damp showing through?
- If there is a water mark or black mould, where is it showing?
- If the wall is wet, where is it showing? What area is affected?
- If wall or ceiling plaster is crumbling or bulging, what area is affected?

### Wall tiles

- What is the problem: tiles fallen off, broken or chipped; seal or grouting damaged or missing?
- What shape are the tiles: square or oblong?
- What colour are they? Are they patterned?
- How many are affected?

# Water, pipes and taps

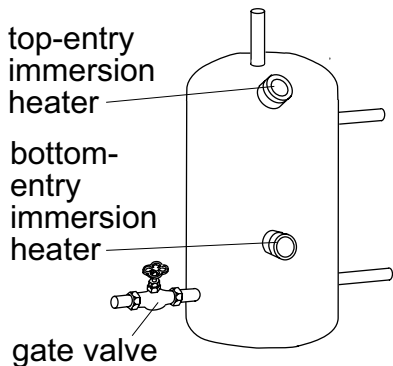

**hot water cylinder, no jacket**

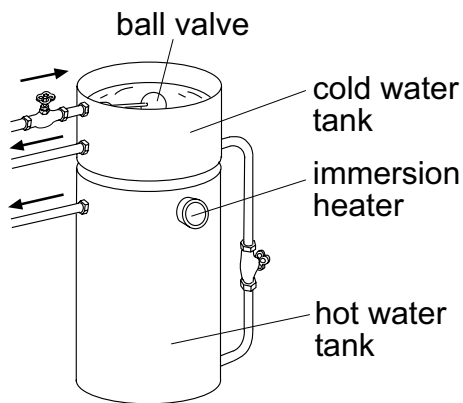

**combination tank**

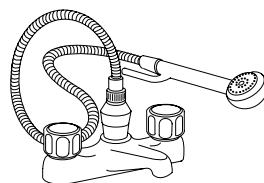
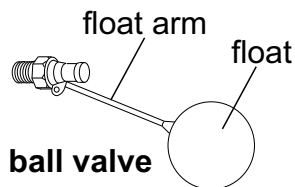
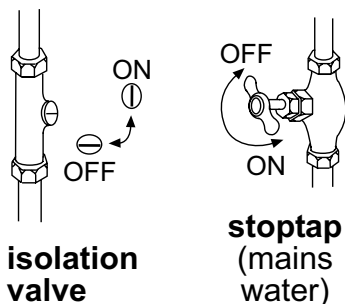
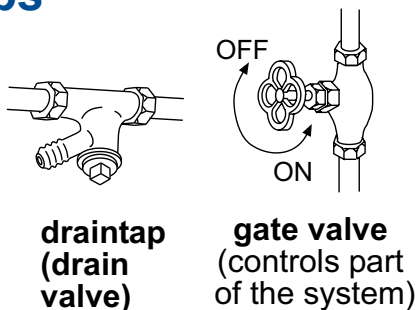
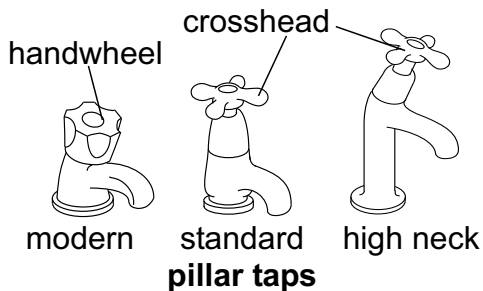

**combined tap and shower attachment**

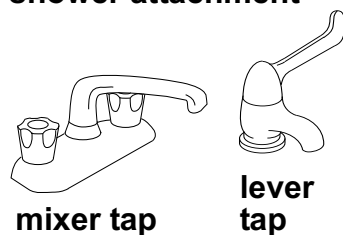

## What we need to know

### Pipes, taps and leaks

- What is the problem: pipe leaking; tap dripping, broken or loose; overflow running or broken; water leaking into the home through the ceiling, from the roof space or the flat above?
- If it is a problem with a tap: is it a hot tap or cold tap? What style of tap is it (see pictures opposite)?
- If a pipe is leaking, where is the leak showing?

**Advice:** If a pipe is leaking, make sure you shut off the supply of water to it (see page 1 for how to do this) or put a container under it until it is fixed.

### Water

- What is the problem: no water supply at all to the home or to part of the home; water coming through taps but not hot; water too hot or not hot enough?
- If there is no water coming out of the tap, do you know if other neighbouring homes are having the same problem? If so, you need to contact your water supplier. See page 1 for what to do.
- If you have water coming out of the hot tap but it isn't hot, have you checked the programmer to see that it is switching on? Do you have a hot water storage container (cylinder)?

**Advice:** If there is no water coming out of the hot taps, turn off the hot water on your heating programmer, or if you use an electric immersion heater (in the hot water cylinder) switch this off at the wall switch.

# Windows

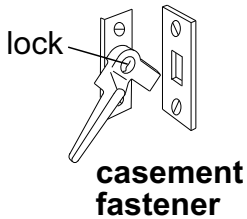
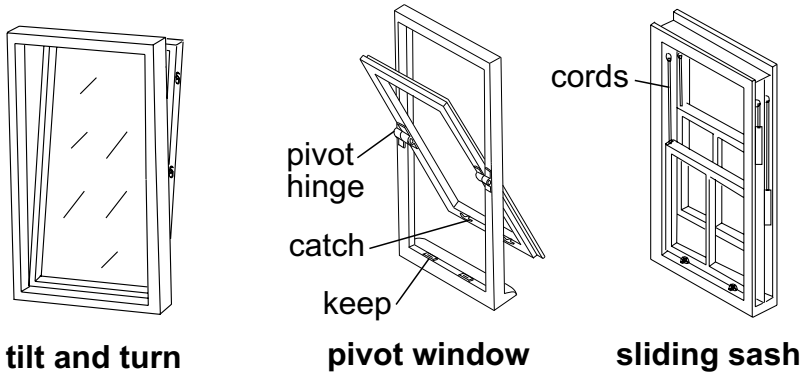
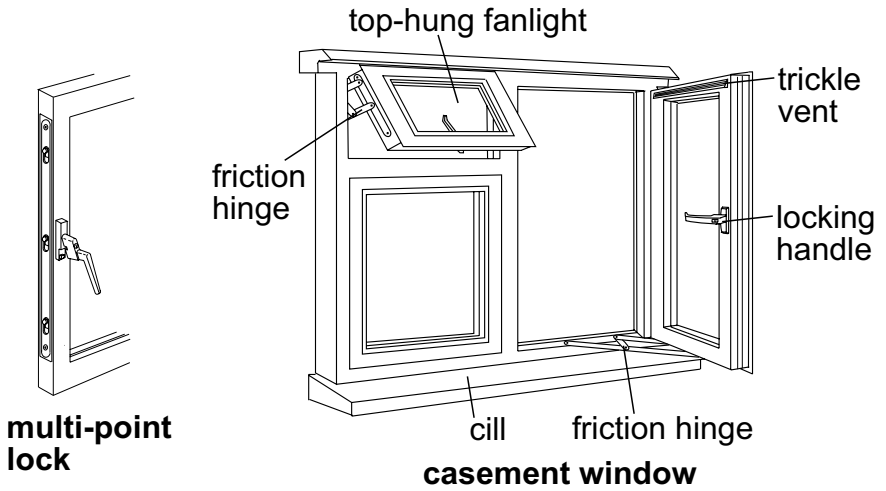

## What we need to know

### For all window problems

- Where is the window: ground floor, first floor or higher?
- Can you still close the window?

### Frames and fasteners

- What is the problem: frame loose, sticking, jammed, damaged or rotten; sash cords broken; stay or fastener broken?
- What is the frame made of: wood, metal or plastic (upvc)?
- What style of frame is it: casement, pivot, tilt and turn, sliding sash?
- If it is draughty, where is the draught coming through: between the wall and the frame, or between the frame and the window?
- What type of fastener is it (see pictures opposite)?

### Cills

- What is the problem: cill loose, damaged, rotten or come off?
- Which cill is it: inside the home or outside?
- What is the cill made of: wood, tiles, concrete, plastic (upvc) or brick?

### Glass

- What is the problem: glass cracked or broken; double glazing misting up between panes; beading loose, broken or missing; putty loose or crumbling?
- What type of glass is it: plain, frosted or wired?
- What size of pane is it (roughly)?
- If you have double-glazing, which pane is broken or cracked: the outside or the inside one?
- If beading is damaged, what is it made of: wood, rubber or plastic (upvc)? How much is affected?
- If putty is loose or crumbling, what is the frame made of: wood or metal?

# Blockages: How to unblock a bath, basin, shower, sink or toilet

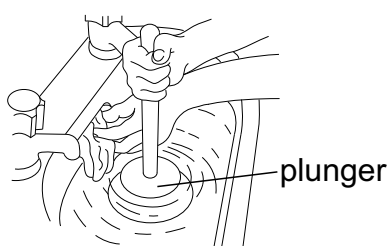

**unblocking a basin or sink**

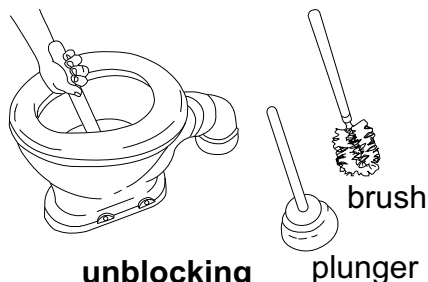

**unblocking a toilet**

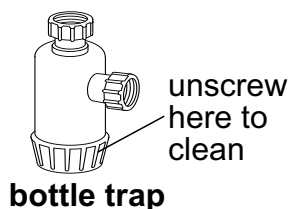
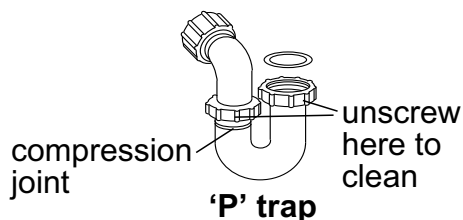

## General advice

- The trap always holds some water which stops air or foul smells coming up the drain.
- Blockages in basins, sinks or showers are usually caused by the build-up of waste in the trap: cooking oil, fat, tea leaves, hair and so on. To stop this happening, you should flush wastepipes and traps with hot water regularly and at least once a month use a clearing product to clear them. (**Do not** use caustic soda as it destroys modern plastic fittings.)
- If more than one fitting (bath, basin, sink or shower) is blocked, the blockage may be in the soil stack or main drain. This will need to be cleared by a contractor. Contact us.
- Blocked toilets are usually caused by unusual objects: nappies, toys or toilet fresheners. You must not use toilets to get rid of rubbish.



## You need:

- bowl or bucket
- jug, cup or mug
- wet cloth
- plunger - for the toilet you can use a toilet brush
- rubber gloves.

## To unblock a bath, basin or sink:

- scoop out most of the water
- hold the cloth tightly over the overflow opening
- place the plunger over the plug hole and pump it up and down quickly.

## To unblock a toilet:

- if the pan is already full, take out some of the water using some form of scoop (for example a jug, cup or mug) and put this into a bucket
- push the brush or plunger to the bottom of the pan
- pump it up and down quickly about 10 times. This should shift the blockage
- flush the toilet to see whether the blockage has gone
- you may need to repeat this process several times before the toilet flushes normally. If there is no improvement, you should contact us.

When you have finished, thoroughly wash your hands and everything you have used.

# Resetting a trip switch: How to put the electricity back on when it has 'tripped' off

If your lights or power go off, it means your trip switches are working properly. You will find the trip switches at the consumer unit (or fuse box). The consumer unit is usually next to the electricity meter or near your front or back door.

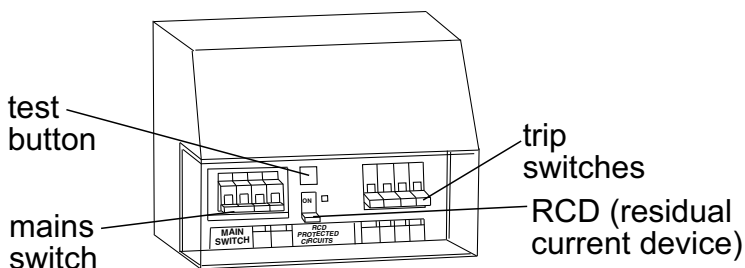

**consumer unit (fuse box)**

## General advice

- Modern electric circuits are fitted with circuit breakers called trip switches. If there is a problem with the electrics in your home, a switch will trip off and break the electricity supply to that circuit. Some consumer units have buttons rather than switches.
- If there's a problem with one of your electrical appliances, leave it unplugged and get a qualified electrician or service engineer to check it.
- If there's a problem with a light, keep it switched off (put some tape over the switch) and let us know immediately.
- Make sure your hands are dry when you touch electrical fittings.

**A trip switch or button usually operates because:**

- there are too many fittings or appliances on a circuit and it has been overloaded
- an appliance is faulty or hasn't been used properly, for example a kettle has been overfilled or a toaster not cleaned of crumbs
- a lead to an appliance, such as a TV or hair drier, is loose or badly connected
- water has leaked into a circuit or spilt onto a plug
- a light bulb has blown
- there's a problem with your immersion heater.

**What to do****To reset a trip:**

- open the cover on the consumer unit so you can get at the trip switches or buttons
- check which switches or buttons have tripped to the OFF position and which rooms (circuit) have been affected
- put the trip switch or buttons back to the ON position
- switch on all lights and appliances again one by one.

**If the trip goes again**, it is probably because one of your appliances is faulty. You need to find out which circuit is being affected and which appliance on that circuit is causing the problem.

- unplug all appliances on the problem circuit, and switch off the immersion heater
- switch the 'tripped' switch to the ON position (if it is a button press it in)
- plug in and switch on the appliances one at a time until the trip goes again. The last one you plugged in will be the faulty appliance. **Do not** use adaptors when testing appliances.

**Do not** carry on resetting it if it keeps tripping off. Contact us.

# Condensation: How to prevent and control it

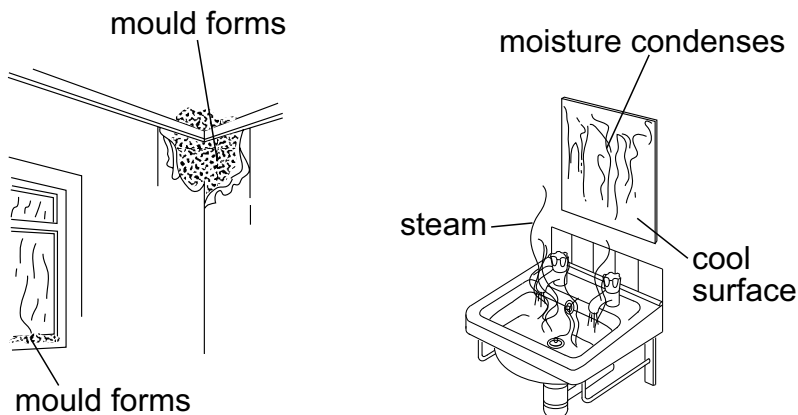

## What is condensation?

- Condensation can occur in any home. You can take steps to prevent it.
- It starts as moisture or steam that is produced by cooking, washing or drying clothes indoors on radiators.
- The moist air turns to water (condenses) on cool surfaces such as walls, mirrors, wall tiles and windows, and even some clothes.
- When the moist air is warm it rises and often ends up on ceilings and in upstairs rooms, and then forms mould.

## If mould forms:

- wipe the mould off immediately with water. **Do not** use washing up liquid
- apply a special solution to the wall. You can get this from a hardware shop or DIY store. Read the instructions carefully before using it. Also, wear rubber gloves. **Do not** use bleach.

## Control excess moisture:

- close kitchen and bathroom doors to prevent steam going into other, colder rooms
- open kitchen and bathroom windows when cooking or washing (and for a while after) so that steam can escape, or use an extractor fan if you have one fitted
- open some windows in other rooms for a while each day to allow a change of air
- do not use bottled gas heaters - the gas produces a lot of moisture
- prevent mould forming by wiping down surfaces where moisture settles
- do not block air vents.

## Produce less moisture:

- dry clothes outdoors whenever possible, otherwise use well ventilated rooms
- cover pans when cooking
- vent any tumble driers to the outside
- cover fish tanks and remember houseplants and pets also produce moisture.

## Keep your house warm:

- take steps to prevent heat escaping your home
- keep your heating on all the time on a low setting when the weather is cold or very wet. This doesn't necessarily cost more than switching it on and off.

# Smoke detectors: How to test them and what to do when the alarm goes off

Some smoke detectors are connected to the main electricity wiring in your home. Others are battery-operated.

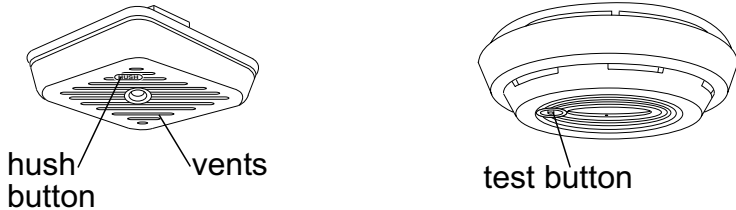

smoke detectors

## If the alarm goes off

- Take your family to where it's easy to escape in case there's a fire.
- Check all rooms for signs of smoke.
- Feel around each door before opening it. If there's any sign of heat, smoke or noise, **don't open the door**.

## If a fire has broken out:

- **don't try to put it out yourself**. Smoke and fumes can kill in minutes
- **get everyone out** of the house and **call** the fire service (**999 or 112**) unless you live in a scheme where there is a 'stay put' procedure
- **don't go back** for any reason.

## If there is no sign of smoke or fire

Something may have made the alarm go off by mistake and you may need to reset it. This can happen if:

- a heater or clothes drier is too near it
- someone smokes a cigarette or pipe near it or a spray is used near it
- there's too much steam or fumes from cooking; roasting meat or burnt toast
- there are strong draughts from nearby doors or windows
- some insects have flown close to it
- the back-up battery (if any) is low.

If you can't find out why it has gone off, contact us. **Never** disconnect the alarm. This will put you and your family at risk.

### To reset the alarm:

- if it has a HUSH button, press the button. The alarm will stop for 10 seconds, but it then beeps every 40 seconds. If the problem doesn't clear after 10 minutes, the alarm will keep going
- if there is no HUSH button, turn off the electricity supply at the consumer unit for at least 15 minutes. Then switch the electricity back on.

### To test your alarm:

- press and hold the test button for a few seconds. The alarm should sound
- if the alarm doesn't sound, try cleaning it and test again
- if the alarm still doesn't sound, contact us.

### To change the battery (only if it is battery-operated):

- Buy a new 9-volt battery.
- Open the detector and unclip the battery from its connections.
- Clip the new battery firmly into place. Make sure it is put in the same way as the one you removed.
- Close the detector and press the test button to check that it works properly



No part of this document may be reproduced or transmitted in any form or by any means, electronic or mechanical, including photocopying, recording, or by any information storage or retrieval system without prior written permission from Omfax Ltd.

Designed and developed by Omfax Systems Limited  
21 The Causeway, Bicester, Oxon OX26 6AN  
[www.omfax.co.uk](http://www.omfax.co.uk) © OMFAX LTD 2009